

RFID Reading Improvement Face to Mechanical Vibration

Chokri Jebali, Riadh Essaadali, Ammar kouki

Department of Electrical Engineering
École de Technologie Supérieure
Montreal, QC, Canada
chokri.jebali@lacime.etsmtl.ca

Khalil Saidi, Marc-André Séguin

Abstract— This paper discusses the mechanical vibration effect of metal structure on RFID and presents a solution to circumvent it. The transmission link between a tag and RFID reader is affected by induced current issued from magnetic coupling. This interference affects mainly the performances of the RFID reader. A new practical technique that avoids the resulting coupling interference is presented in this paper. The RFID system is analyzed at low frequency to provide a new solution that answers to the requirements of industrial applications according to ISO standards. The RFID reader's antenna is accurately simulated with EMWorks software under different environment magnetic conditions in order to identify the main source of interference problem. Experimental results validate the solution presented in this paper and prove its enhanced performances.

Keywords—RFID, tag, reader antenna, magnetic coupling, induced current, magnetic field, vibration.

I. INTRODUCTION

In recent years, Radio Frequency Identification (RFID) technology is involved in many high specific industrial applications [1]. Over an acceptable distance, RFID is used for identification purposes without contact and without a direct physical vision [2]. A large set of unique identifications can be supported by RFID tags. Different types of RFID applications exist.

There are two categories of RFID devices: (i) Active tags require a power source and its lifetime is limited to the number of reading operations [3], (ii) the passive tag has a superior undefined operational life because it is battery-less and able to fit any practical use. The reader is a transceiver that generates power and communicates with a tag. The power radiated from the reader is captured by the tag coil and generates an inducer current to supply the tag-ship and can be sustained during its operation [4]. Needed power is typically between $10\mu\text{W}$ and 1mW depending on the tag type[1]. The response of the tag is an analog modulated signal [2]. Depending on the application, the modulation can be amplitude (ASK), frequency (FSK) or phase (PSK) shift keying [2].

Some limited researches have been performed to assess the acoustic and mechanical interference effect on RFID reader performance [4]. Many in-lab tests prove that RFID system is liable to mechanical perturbations such as a random vibration with short duration and high intensity. The paper is organized as follow. The first section introduces the technical problem and focuses on the sensitivity of RFID to the mechanical

vibration. The second section presents a detailed explanation of the solution concept to circumvent the mechanical vibration effect. The third section includes measurement results to validate the solution concept.

II. RESEARCH PROBLEMATIC: ELECTROMAGNETIC INTERFERENCE FROM MECHANICAL VIBRATION

In this section, the coupling between an antenna reader and a tag based on magnetic induction is introduced. When the reader is activated, it generates an AC current through an antenna (coil) that radiates an electromagnetic field around the shape of the antenna in a specific coverage [2]. The rayon of the covered area depends, mainly, on the coil current. Thus, when a tag enters to the covered area, it is automatically powered. Then, it starts to communicate without any interruption during activation mode, by sending its identity (ID). This operating mode is based on Faraday's principle where the tag that is powered by the near-field antenna coupling sends back the data to the reader using analog modulations [1]. The tag gives rise to a magnetic field generated by its coil. This field is then detected by the reader coil and is converted to a small rise of the current flowing through it. Fig. 1 illustrates the communication rule between the passive tag and the reader.

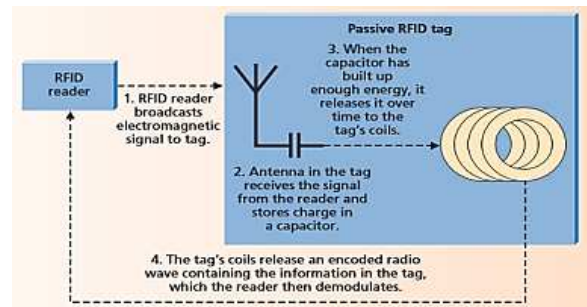

Fig. 1. Simplified view of data transfer in LF passive RFID tags [2]

Current change through the antenna is recovered by the reader. The choice of the modulation type to be applied is depending on many factors such as: the data transfer rate, the number of ID bits and the additional redundancy bits that are placed in the code to remove errors introduced by the communication channel's noise. The RFID reader antenna is installed in a transport trailer's door, where each object bearing a tag will be detected while entering or leaving the trailer. In normal condition, the object is detected and the tag's

ID is stored. As the object moves inside the trailer, the reader can't read the tag's ID because of the interference or noise. In addition to the wireless channel's noise, RFID is sensitive to mechanical vibrations. Indeed, in a specific application where a heavy object having a tag passes through the trailer door and producing a vibration of the trailer structure generates a noise signal that is added to the radiated signal at the reader's antenna already installed in the door.

Fig. 2 presents the in laboratory test-bed metallic structure that produces the same phenomena as in the original case when vibration effects take place. The characterisation of mechanical and magnetic interferences generated by the metallic structure shown in Fig. 2 provides the same behavior as in the transport trailer scenario. The tags used in this study are full duplex. The reader transmits continuously a carrier at 134.2 kHz, the reradiated response from the tag is an amplitude modulated signal centered at 4 kHz.

A set of a random mechanical forces are applied to the metallic structure shown in Fig. 2 results to a kind of an effective tag response behavior generated by the induced current of the structure at the same frequency and with a high amplitude level. The clean measured carrier, drawn in the left, is the RF signal emitted by the reader antenna while the noisy signal, in the right, represents the induced current generated by the metallic structure caused by magnetic induction.

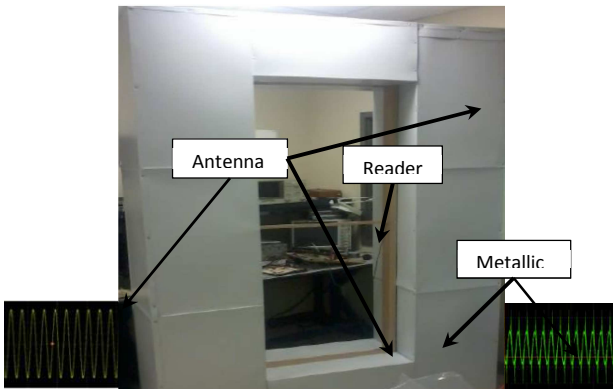

Fig. 2. Metallic structure and RFID antenna for the test bed of RFID reader.

In order to identify the source of the problem, a simulation with a full-wave 3D electromagnetic simulator EMWorks based on the finite-elements method [5] is carried out. Fig. 3(a) and 3(b) show respectively the magnetic field in the antenna's reader, and its resultant induced magnetic field in the metallic structure on the right. In fig. 3(c), a cross-sectional view of the trailer showing the variation of induced current density along the length of the material. It is clear that the distribution of the induced current in the conductor material of the trailer is very significant and reaches 1445 Amp/m^2 . The reader's handicap is mainly due to the induced current raising from the conductor trailer's material which is close to the reader coil. When the trailer vibrates, an induced current is raised and the total current floating through the antenna coil changes. The erroneous current that is recovered, as a signal, causes errors on the tag's ID code.

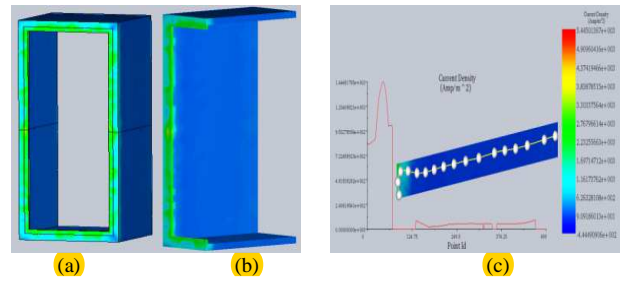

Fig. 3. Total magnetic field of the reader antenna (a) and (b) of the metallic structure, (c) the induced current density distribution in the cross-sectional view of the metallic structure.

III. THE CONCEPT OF SOLUTION: ON RFID VIBRATIONS EFFECT REDUCING TECHNIQUE

The aim of this section is to introduce a solution concept to circumvent vibrations effect that alters the tag's signal. Two technical solutions are proposed after a characterization procedure. In order to analyze vibration's effect, a set of random forces are applied to the metallic structure shown in Fig. 2 and the signals emanating from the tag are recorded. The analysis of these signals shows that the vibration affects mainly the envelope of the received signal as shown in Fig. 4. In this figure the behavior of the tag's response in standard conditions (without vibration) and under vibration effects are compared. It is well seen that there is a high correlation between the vibration signal and the distortions of the tag's signal.

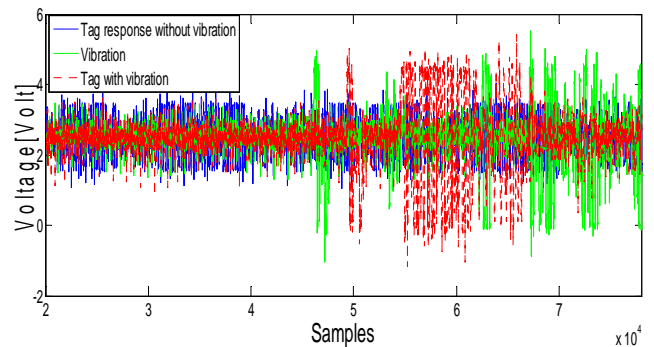

Fig. 4. Characterization of the correlation between mechanical vibrations and tag's signal distortion

The first solution concept consists on reducing power level from the reader to the tag and ensuring that the tag's load is perfectly matched to reduce the amplitude of induced magnetic field in the metal structure which is proportional to the incident power. Digital signal processing, that is a simple average of a number of frames during the active period of the tag, is applied to the signal envelope to extract the ID information. However, decreasing the power leads to receiver sensitivity problems caused by channel conditions such as path-loss, wave absorption and reflection. The required distance to detect a tag is significantly reduced. Moreover, the induced current between the reader's antenna and the metallic structure is present and is still the main source of tag detection problem.

An improved solution concept consists on keeping the same power level and cancelling the vibration signal followed by a digital signal processing applied to the signal's envelope. As shown in Fig. 5, all samples with level voltage, higher than a given threshold, caused by the mechanical vibrations are suppressed and replaced by a null signal (see the red curve). The average of the resulting signal during the active period of the tag is calculated to decrease the reading error probability.

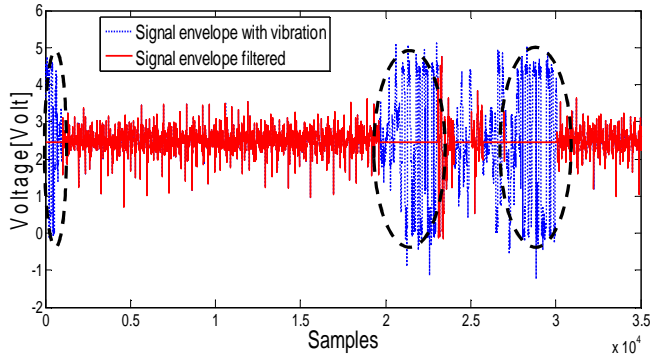

Fig. 5. Delete of the vibration effects amplitude during the reception of the tag response.

IV. VALIDATION OF VIBRATIONS EFFECT REDUCING TECHNIQUE

In this section, the solution concepts presented in the previous section are implemented and compared based on real measurements. Fig. 6 illustrates the diagram of an RFID base station transceiver. It includes also a prototype of an RFID system. The transmitter includes a simple local oscillator that generates a carrier at 134.2 kHz and a high power amplifier. The receiver includes the analog and the baseband parts. The analog parts contain an envelope detector to suppress the carrier signal followed by a low noise amplifier and an analog-to-digital converter. The baseband part includes a frame decoder followed by bloc to detect CRC errors. Decoded data are transferred to Matlab for processing.

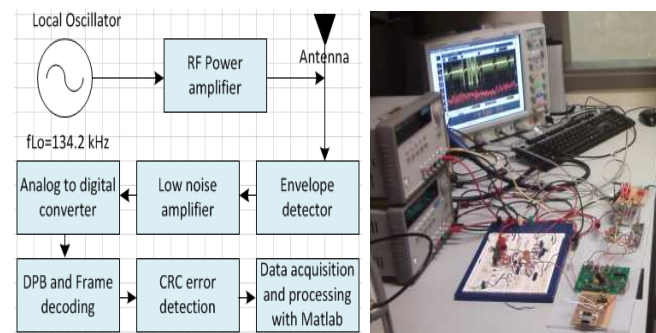

Fig. 6. Architecture of RFID base station (Left) and Test bed of an RFID system (Right)

After the implementation of the first solution concept, the resulting measured envelope is still distorted which gives an erroneous tag's ID as depicted with red color in fig. 7. Therefore, an improved signal processing algorithm is applied to the affected envelope. The algorithm's goal is to delete high noisy levels in the envelope signal caused by vibrations as

shown in fig. 5. Then, the mean value of all recorded samples of the tag is applied. As shown in fig. 7, the average results of the improved tag detection are carried out by the green curve which corresponds to the improved filtered measurements. It proves that the tag reading processing becomes independent of mechanical vibration effects, compared to the red one which shows the deficiency of the reader detection. This processing increases the reader detection to 95% of the previous problems and helps the use of the updated reader to jump the vibration problem.

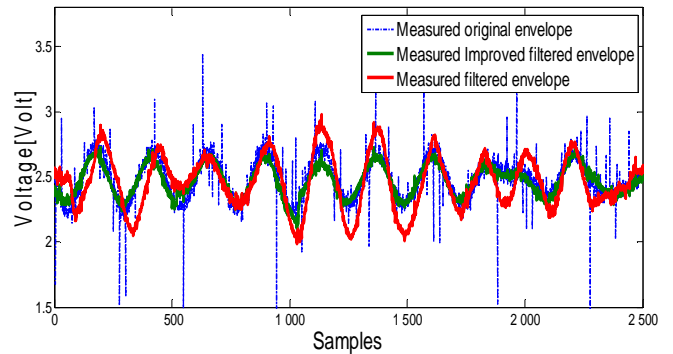

Fig. 7. Measured signal envelope after digital signal processing for three cases, original envelope, processed envelope and improved envelope.

V. CONCLUSION

In this paper, the sensitivity of RFID tag detection to mechanical vibration is discussed. The source of the problem is identified by performing electromagnetic simulations. The presence of conducting material close to the antenna reader, when coupled to the structure's vibration generates an induced current that will be added to the envelope of the received signal from the tag. Many solution concepts are introduced, in this paper, to circumvent the effect of the vibration. A comparison between them shows that the digital filtering coupled with average processing struggles any mechanical vibration effect. In-laboratory measurements validate the proposed technique.

REFERENCES

- [1] D. Paret RFID at Ultra and Super High Frequency, United Kingdom: J. Wiley & Sons, 2009.
- [2] R. Weinstein, "RFID: a technical overview and its application to the enterprise," IEEE Computer Society, IT Professional, vol. 7, pp. 27-33, June 2005.
- [3] A. Bletsas, A. G. Dimitriou, and J. N. Sahalos, "Improving Backscatter Radio Tag Efficiency," IEEE Trans. Microwave Theory & Tech., vol. 58, no. 6, pp. 1502-1509, June 2010.
- [4] P. V. Nikitin, K. V. S. Rao, R. Martinez, and S. F. Lam, "Sensitivity and Impedance Measurements of UHF RFID Chips," IEEE Trans. Microwave Theory & Tech., vol. 57, no. 5, pp. 1297-1302, Mars 2009.
- [5] EMWorks www.emworks.com